



INSTRUCTION MANUAL

VHF MARINE TRANSCEIVER IC-M36

This device complies with Part 15 of the FCC Rules. Operation is subject to the condition that this device does not cause harmful interference.



Thank you for choosing this Icom product.

This product is designed and built with Icom's state of the art technology and craftsmanship. With proper care, this product should provide you with years of trouble-free operation.

IMPORTANT

READ ALL INSTRUCTIONS carefully and completely before using the transceiver.

SAVE THIS INSTRUCTION MANUAL—This instruction manual contains important operating instructions for the IC-M36 VHF MARINE TRANSCEIVER.

EXPLICIT DEFINITIONS

WORD	DEFINITION
⚠ DANGER	Personal death, serious injury or an explosion may occur.
⚠ WARNING	Personal injury, fire hazard or electric shock may occur.
CAUTION	Equipment damage may occur.
NOTE	If disregarded, inconvenience only. No risk of personal injury, fire or electric shock.

FEATURES

Floating on water

The transceiver floats on fresh or salt water, even when the supplied accessories are attached.

- When a third-party battery pack, strap, antenna, and so on, is used, it may sink.
- The battery contacts may be prone to rust if the transceiver is kept floating on the water.



Clear voice boost

The transceiver has a noise detection function which enables automatic volume adjustment, and the volume loud function that enables you to maximize the volume level instantly to provide clear communication in the noisy marine environments.

Noise cancelling microphone

The sub-microphone on the rear panel inverts the phase and cancels out the ambient noise from the main microphone. As a result, the transceiver can reduce the influence of the background noise (particularly treble noise) on the transmitted signal.

- The noise cancellation can produce no effect according to conditions such as loudness and type of noise, or the position and distance between the noise source and the microphone, etc.
- The noise cancellation does not work when an optional external speaker-microphone is connected.

IN CASE OF EMERGENCY

If your vessel requires assistance, contact other vessels and the Coast Guard by sending a distress call on Channel 16.

○ **USING CHANNEL 16**

DISTRESS CALL PROCEDURE

1. "MAYDAY MAYDAY MAYDAY."
2. "THIS IS " (name of vessel)
3. Your call sign or other indication of the vessel.
4. "LOCATED AT " (your position)
5. The nature of the distress and assistance required.
6. Any other information which might facilitate the rescue.

RECOMMENDATION

CLEAN THE TRANSCEIVER THOROUGHLY IN A BOWL OF FRESH WATER after exposure to saltwater, and dry it before operating. Otherwise, the transceiver's keys, switches, and controllers may become unusable, due to salt crystallization, and/or the charging terminals of the battery pack may corrode.

NOTE: If the transceiver's waterproof protection appears defective, carefully clean it with a soft, damp (fresh water) cloth, then dry it before operating.

The transceiver may lose its waterproof protection if the case, jack cap, or connector cover is cracked or broken, the transceiver has been dropped, or the battery pack is detached.

Contact your Icom distributor or your dealer for advice.

FCC INFORMATION

This equipment has been tested and found to comply with the limits for a Class A digital device, pursuant to part 15 of the FCC Rules. These limits are designed to provide reasonable protection against harmful interference when the equipment is operated in a commercial environment. This equipment generates, uses, and can radiate radio frequency energy and, if not installed and used in accordance with the instruction manual, may cause harmful interference to radio communications.

Operation of this equipment in a residential area is likely to cause harmful interference in which case the user will be required to correct the interference at his own expense.

PRECAUTIONS

⚠ **DANGER! NEVER** short terminals of the battery pack. Also, current may flow into nearby metal objects such as a key, so be careful when placing the battery packs (or the transceiver) in handbags, and so on. Simply carrying with or placing near metal objects such as a key, and so on may cause shorting. This may damage not only the battery pack, but also the transceiver.

⚠ **DANGER! NEVER** use and charge other than the specified Icom battery pack with Icom radios or Icom charger. Only Icom battery pack is tested and approved for use and charge with Icom radios or Icom charger. Using third-party or counterfeit battery packs or charger may cause smoke, fire, or cause the battery to burst.

⚠ **DANGER! NEVER** operate the transceiver near unshielded electrical blasting caps or in an explosive atmosphere.

⚠ **WARNING! NEVER** connect the transceiver to an AC outlet. This may pose a fire hazard or result in an electric shock.

⚠ **WARNING! NEVER** hold the transceiver so that the antenna is closer than 2.5 cm (1 inch) from exposed parts of the body, especially the face or eyes, while transmitting. The transceiver will perform best if the microphone is 5 to 10 cm (2 to 4 inches) away from the lips and the transceiver is vertical.

PRECAUTIONS (Continued)

CAUTION: DO NOT attach the battery unless the flexible antenna, battery pack and jack cover are securely attached to the transceiver. Confirm that the antenna and battery pack are dry before attaching. Exposing the inside of the transceiver to dust or water can cause serious damage to the transceiver.

After exposure to water, clean the battery contacts thoroughly with fresh water and dry them completely to remove any water or salt residue.

NEVER connect the transceiver to a power source other than the BP-251 (option) or BP-252. Such a connection will ruin the transceiver.

DO NOT operate or place the transceiver in direct sunlight or in areas with temperatures below -20°C (-4°F) or above $+60^{\circ}\text{C}$ ($+140^{\circ}\text{F}$).

DO NOT use harsh solvents such as Benzine or alcohol when cleaning, as they will damage the transceiver surfaces.

DO NOT push [PTT] when not actually intending to transmit.

DO NOT modify the transceiver. The transceiver warranty does not cover any problems caused by unauthorized modifications.

PLACE the transceiver in a secure place to avoid inadvertent use by unauthorized persons.

KEEP the transceiver at least 0.9 meters (3.0 ft) away from your vessel's magnetic navigation compass.

BE CAREFUL! The transceiver's right-side panel will become hot when operating continuously for long periods of time.

BE CAREFUL! The transceiver meets IPX7* requirements for waterproof protection. However, once the transceiver has been dropped, waterproof protection cannot be guaranteed because of possible damage to the transceiver's case or the waterproof seal.

* Only when the BP-251 (option) or BP-252, flexible antenna, [SP MIC] cap is attached.

MAKE SURE to turn OFF the transceiver power before connecting or disconnecting the supplied or optional accessory.

Icom is not responsible for the destruction, damage to, or performance of any Icom or non-Icom equipment, if the malfunction is because of:

- Force majeure, including, but not limited to, fires, earthquakes, storms, floods, lightning, other natural disasters, disturbances, riots, war, or radioactive contamination.
- The use of Icom transceivers with any equipment that is not manufactured or approved by Icom.

For USA only

CAUTION: Changes or modifications to this device, not expressly approved by Icom Inc., could void your authority to operate this device under FCC regulations.

Icom, Icom Inc. and the Icom logo are registered trademarks of Icom Incorporated (Japan) in Japan, the United States, the United Kingdom, Germany, France, Spain, Russia, Australia, New Zealand, and/or other countries. AquaQuake is a trademark of Icom Incorporated.

TABLE OF CONTENTS

IMPORTANT	i	5 SCAN OPERATION	14–15
EXPLICIT DEFINITIONS	i	■ Scan types	14
FEATURES	i	■ Setting TAG channels	15
IN CASE OF EMERGENCY	ii	■ Starting a scan	15
RECOMMENDATION	ii	6 DUALWATCH/TRI-WATCH	16
FCC INFORMATION	iii	■ Description	16
PRECAUTIONS	iii	■ Operation	16
1 OPERATING RULES	1	7 SET MODE	17–20
2 SUPPLIED ACCESSORIES AND ATTACHMENTS	2–3	■ Set mode programming	17
■ Supplied accessories	2	■ Set mode items	18
■ Attachments	2	8 BATTERY CHARGING	21–24
3 PANEL DESCRIPTION	4–7	■ Battery caution	21
■ Front, top, side and rear panels	4	■ Supplied battery charger	23
■ Function display	6	■ Optional battery case	23
4 BASIC OPERATION	8–13	■ Optional battery charger	24
■ Channel selection	8	9 OPTIONAL SPEAKER-MICROPHONE	25
■ Receiving and transmitting	10	■ HM-165 descriptions	25
■ Call channel programming	11	■ Attachment	25
■ Adjusting the volume level	11	10 TROUBLESHOOTING	26
■ Volume loud function	12	11 VHF MARINE CHANNEL LIST	27
■ Volume mute function	12	12 SPECIFICATIONS AND OPTIONS	28
■ Adjusting the squelch level	12	■ Specifications	28
■ Lock function	13	■ Options	28
■ Monitor function	13	13 SAFETY TRAINING INFORMATION	29
■ Automatic backlighting	13		
■ AquaQuake water draining function	13		

◇ Priorities

- Read all rules and regulations pertaining to priorities and keep an up-to-date copy handy. Safety and distress calls take priority over all others.
- You must monitor Channel 16 when you are not operating on another channel.
- False or fraudulent distress calls are prohibited under law.

◇ Privacy

- Information overheard but not intended for you cannot lawfully be used in any way.
- Indecent or profane language is prohibited.

◇ Radio licenses

(1) SHIP STATION LICENSE

You must have a current radio station license before using the transceiver. It is unlawful to operate a ship station which is not licensed.

Inquire through your dealer or the appropriate government agency for a Ship-Radiotelephone license application. This government-issued license states the call sign which is your craft's identification for radio purposes.

(2) OPERATOR'S LICENSE

A Restricted Radiotelephone Operator Permit is the license most often held by small vessel radio operators when a radio is not required for safety purposes.

The Restricted Radiotelephone Operator Permit must be posted or kept with the operator. Only a licensed radio operator may operate a transceiver.

However, non-licensed individuals may talk over a transceiver if a licensed operator starts, supervises, ends the call and makes the necessary log entries.

A current copy of the applicable government rules and regulations is only required to be on hand for vessels in which a radio telephone is compulsory. However, even if you are not required to have these on hand it is your responsibility to be thoroughly acquainted with all pertinent rules and regulations.

NOTE: Even though the IC-M36 is capable of operation on VHF marine channels 21A, 23A, 81A, 82A and 83A, according to FCC regulations these simplex channels cannot be lawfully used by the general population in USA waters.

■ Supplied accessories

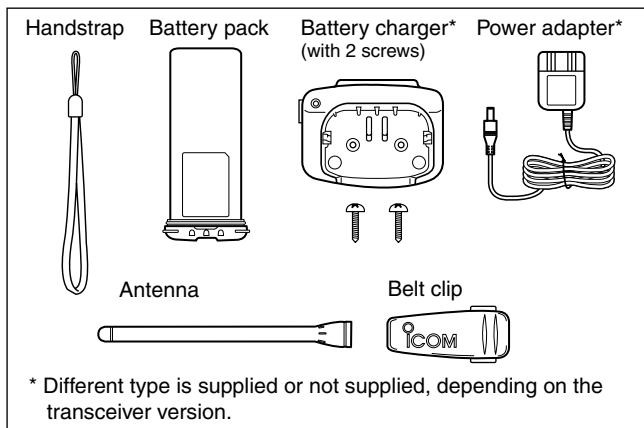

■ Attachments

◇ Flexible antenna

Connect the supplied flexible antenna to the antenna connector.

CAUTION:

- **NEVER** carry the transceiver by holding only the antenna.
- Transmitting without an antenna may damage the transceiver.

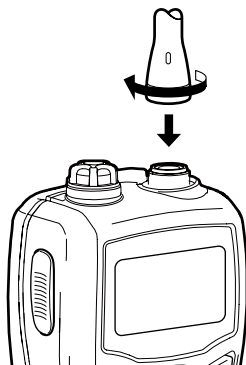

◇ Handstrap

Pass the handstrap through the loop on the back side of the transceiver. This facilitates carrying.

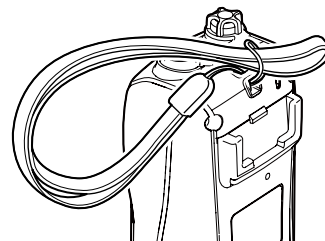

◇ Belt clip

Attach/detach the belt clip to the transceiver.

To attach the belt clip

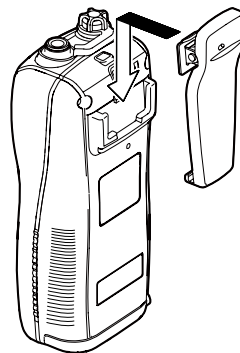

To detach the belt clip

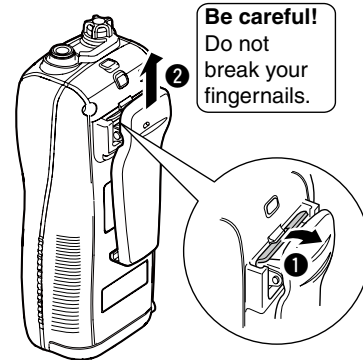

◆ **Battery pack**

To remove the battery pack:

Turn the screw counter clockwise one quarter turn, then pull the battery pack in the direction of the arrow, as shown below.

To attach the battery pack:

Insert the battery pack in the transceiver completely, then turn the screw clockwise one quarter turn.

NEVER remove or insert the battery pack when the transceiver is wet or soiled. This may result water or dust getting into the transceiver/battery pack and may result in the transceiver being damaged.

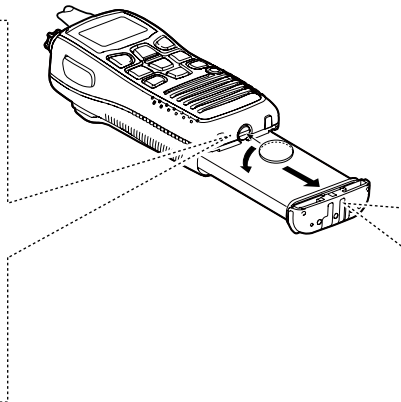
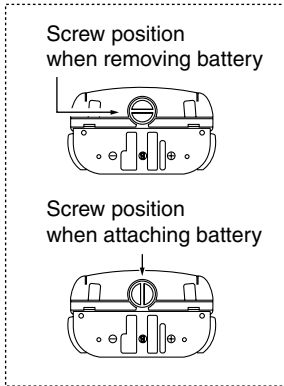

NOTE: When removing or attaching the battery pack, use a coin or standard screwdriver to loosen or tighten the bottom screw.

CAUTION: When attaching or removing a battery pack, make sure the rubber seal is correctly set in the groove of the battery pack. If the seal is not correctly in the groove, it may be damaged when attaching the battery pack. If the seal is damaged, waterproof protection is not guaranteed.

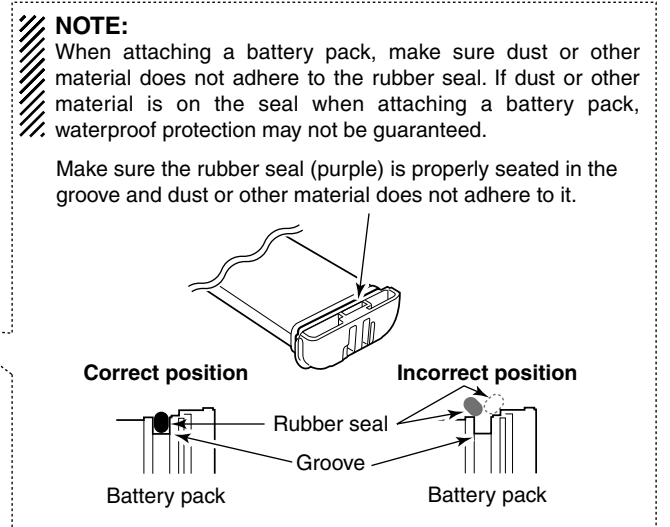

3

PANEL DESCRIPTION

■ Front, top, side and rear panels

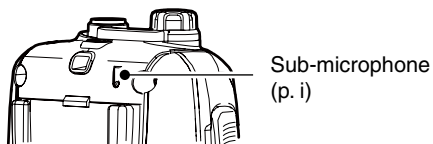
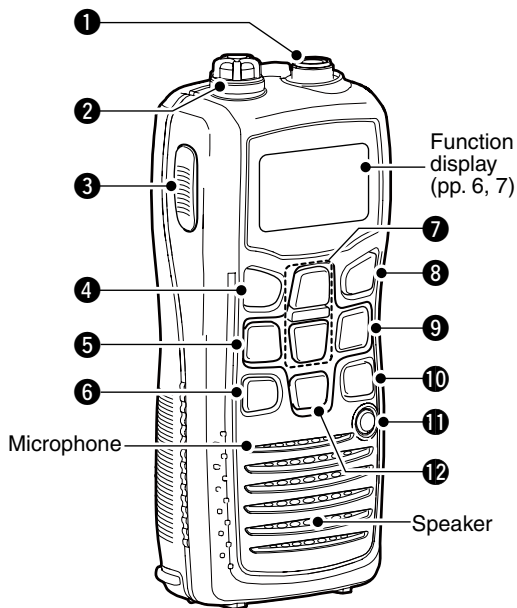

1 ANTENNA CONNECTOR (p. 2)

Connects to the supplied antenna.

2 SPEAKER-MICROPHONE CONNECTOR [SP MIC] (p. 25)

Connects to the optional external speaker-microphone.

NOTE: Attach the [SP MIC] cap when the optional speaker-microphone is not used. Otherwise, water will get into the transceiver.

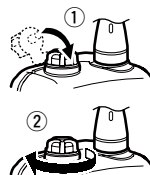

1 Attach the [SP MIC] cap.

2 Then rotate it completely clockwise.

3 PTT SWITCH [PTT]

Hold down to transmit, release to receive. (p. 10)

4 CHANNEL 16 KEY [16 9]

➔ Push to select Channel 16. (p. 8)

➔ Hold down for 1 second to select the Call channel. (p. 8)

➔ When the Call channel is selected, hold down for 3 seconds to enter the Call channel entry mode. (p. 11)

➔ While in the set mode, push to return to the normal mode. (p. 17)

5 VOLUME/SQUELCH/MONITOR KEY [VOL/SQL MONI]

- Push to enter the volume adjustment mode and the squelch adjustment mode. (pp. 11, 12)

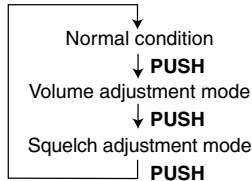

- Push to restore the changed volume level by the noise detection, volume loud, or volume mute function to the original. (pp. 12, 20)
- Hold down for 1 second to activate the monitor function. (p. 13)
- While holding down this key, turn ON the power to enter the set mode. (p. 17)
- While in the set mode, push to select an item. (p. 17)

6 SCAN/DUAL KEY [SCAN DUAL]

- Push to start or stop normal or priority scan. (p. 15)
- Hold down for 1 second to enter the watch mode. (p. 16)
- Push to exit the watch mode. (p. 16)
- Hold down this key and [**Hi/Lo**], to activate the AquaQuake function. (p. 13)

7 CHANNEL UP/DOWN KEYS [▲**]/[**▼**]**

- Selects an operating channel. (pp. 8, 9)
- While in the set mode, selects the setting or value of an item. (p. 17)
- Checks TAG channels or changes scanning direction during scan. (p. 15)

8 FAVORITE/TAG KEY [FAV TAG]

- Push this key to select the favorite (TAG) channels with ignoring untagged channels in a channel group in sequence. (p. 8)
- Hold down for 1 second to set or clear TAG for the displayed channel. (p. 15)
- While holding down this key, turn ON the power to clear or set all TAG channels in the selected channel group. (p. 15)

9 CHANNEL/WEATHER CHANNEL KEY [CH/WX U/I/C]

- Push to switch between the regular channel and weather channel. (p. 9)
- Hold down for 1 second to select the channel group from USA, International and Canada. (p. 9)
- Push to return to the previous channel before selecting Channel 16 or the Call channel.

10 TRANSMIT POWER/LOCK KEY [Hi/Lo]

- Push to select the output power from high and low. (p. 10)
- Hold down for 1 second to turn the key lock function ON or OFF. (p. 13)

11 POWER KEY []

- Hold down for 1 second to turn the power ON or OFF.

12 LOUD/MUTE KEY [LOUD MUTE]

- Push to turn the volume loud function ON or OFF. (p. 12)
- Hold down for 1 second to turn ON the volume mute function, and push to turn OFF the function. (p. 12)

3 PANEL DESCRIPTION

■ Function display

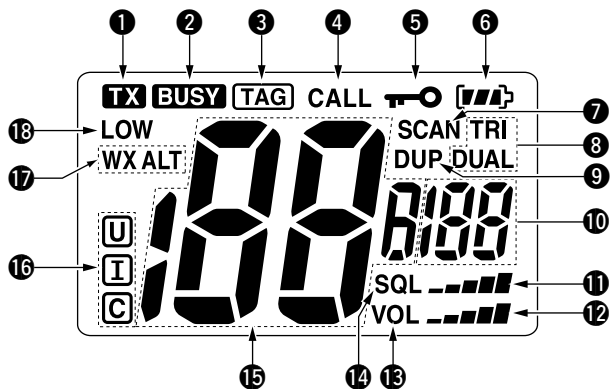

1 TRANSMIT INDICATOR (p. 10)

Appears while transmitting.

2 BUSY INDICATOR

➔ Appears when receiving a signal or when the squelch opens. (p. 10)

➔ Blinks while monitoring. (p. 13)

3 TAG CHANNEL INDICATOR (p. 15)

Appears when a TAG channel is selected.

4 CALL CHANNEL INDICATOR (p. 8)

Appears when the Call channel is selected.

5 LOCK INDICATOR (p. 13)

Appears while the lock function is activated.

6 BATTERY INDICATOR

Indicates remaining battery power.

Indication	[]	[]	[]	[]
Battery level	Full	Middle	Charging required	No battery

[|||||] blinks when the battery is over charged.

[] blinks when the battery is exhausted.

7 SCAN INDICATOR (p. 15)

Blinks during scan.

8 DUALWATCH/TRI-WATCH INDICATORS (p. 16)

“DUAL” appears during Dualwatch, “TRI” appears during Tri-watch.

9 DUPLEX INDICATOR

Appears when a duplex channel is selected.

10 SUB CHANNEL READOUT

➔ Indicates Channel 16 during priority scan, Dualwatch or Tri-watch. (p. 16)

➔ Indicates the set mode item while in the set mode. (p. 17)

➔ Indicates the volume level while in the volume adjustment mode. (p. 11)

➔ Indicates the squelch level while in the squelch adjustment mode. (p. 12)

11 SQUELCH LEVEL INDICATOR

Shows the squelch level.

12 VOLUME LEVEL INDICATOR

➔ Shows the volume level.

➔ The bars repeatedly appear in ascending order when the volume loud function is activated. (p. 12)

➔ Blinks while the volume mute is activated. (p. 12)

13 VOLUME LEVEL ADJUSTING INDICATOR (p. 11)

➔ Blinks while adjusting the volume level.

➔ This indicator and the volume level indicator alternately appear while the volume level is turned up by the noise detection function. (p. 20)

14 SQUELCH LEVEL ADJUSTING INDICATOR (p. 12)

Blinks while adjusting the squelch level.

15 CHANNEL NUMBER READOUT

➔ Indicates the selected operating channel number.

➔ In the set mode, indicates the selected option or value. (p. 17)

16 CHANNEL GROUP INDICATOR (p. 9)

“**U**” appears when USA, “**I**” appears when International, “**C**” appears when Canadian channel group is selected each.

17 WEATHER CHANNEL/WEATHER ALERT INDICATORS

(p. 9)

➔ “**WX**” appears when the weather channel group is selected.

➔ “**WX ALT**” appears while the weather alert function is activated, blinks when the alert tone is received.

18 LOW POWER INDICATOR (p. 10)

➔ “**LOW**” appears when low power is selected.

➔ “**LOW**” blinks when switching to the forced low power mode because of a high temperature error or low voltage.

■ Channel selection

IMPORTANT: Prior to using the transceiver for the first time, the battery pack must be fully charged for optimum life and operation. To avoid damage to the transceiver, turn OFF the power while charging.

◇ Channel 16

Channel 16 is the distress and safety channel. It used for establishing initial contact with a station and for emergency communications. Channel 16 is monitored during both Du-alwatch and Tri-watch. While in the standby mode, you must monitor Channel 16.

- ① Push **[16 9]** momentarily to select Channel 16.
- ② Push **[CH/WX U/I/C]** to return to the channel used before Channel 16, or push **[▲]/[▼]** to select a channel.

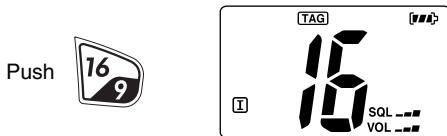

Convenient!

While holding down **[FAV TAG]**, push **[▲]/[▼]** to select the favorite (TAG) channels with ignoring untagged channels in the selected channel group in sequence.

- Pushing **[FAV TAG]** only advances the displayed TAG channel.
- The favorite channels are selected using the TAG channel setting. (p. 15)

◇ Channel 9 (Call channel)

Each regular channel group has separate leisure-use Call channels. The Call channel is monitored during Tri-watch. The Call channels can be programmed (p. 11) and are used to store your most often used channel in each channel group for quick recall.

- ① Hold down **[16 9]** for 1 second to select the Call channel of the selected channel group.
 - “CALL” and Call channel number appear.
 - Each channel group can have an independent Call channel after entering a Call channel. (p. 11)
- ② Push **[CH/WX U/I/C]** to return to the channel used before the Call channel, or push **[▲]/[▼]** to select a channel.

Hold down for
1 second

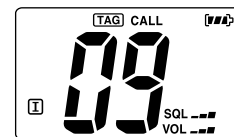

◇ **USA, International and Canadian channels**

The transceiver is preset with 59 USA, 59 International and 63 Canadian channels. These channel groups may be specified for the operating area.

- ① Push **[CH/WX U/I/C]** to select a regular channel.
 - If a weather channel appears, push **[CH/WX U/I/C]** again.
- ② Hold down **[CH/WX U/I/C]** for 1 second to change the channel group. Repeat to advance to the next group.
 - USA, International and Canadian channel groups can be selected in sequence.
- ③ Push **[▲]/[▼]** to select a channel.
 - “DUP” appears for duplex channels.

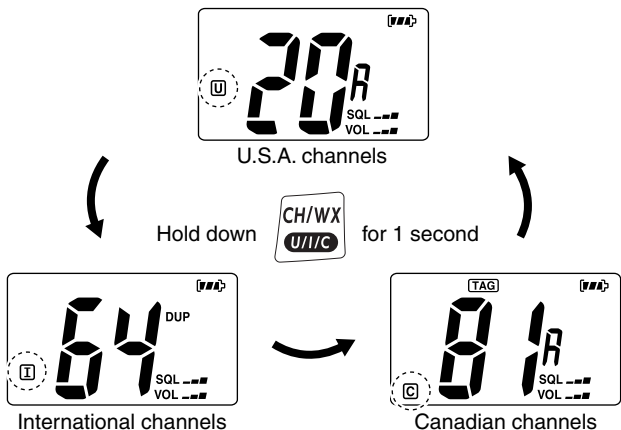

◇ **Weather channels**

The transceiver has 10 preset weather channels. These are used for monitoring broadcasts from the NOAA (National Oceanic and Atmospheric Administration).

The transceiver can automatically detect a weather alert tone on the selected weather channel while receiving another channel or during scan. (p. 18)

- ① Push **[CH/WX U/I/C]** once or twice to select a weather channel.
 - “WX” appears when a weather channel is selected.
 - “WX ALT” appears when the weather alert function is turned ON. (p. 18)
- ② Push **[▲]/[▼]** to select a weather channel.

Push **[CH/WX U/I/C]** once or twice.

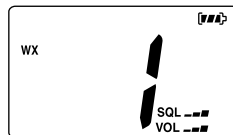

Weather alert is OFF.

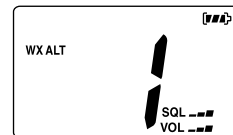

Weather alert is ON.

4 BASIC OPERATION

■ Receiving and transmitting

CAUTION: Transmitting without an antenna may damage the transceiver.

- ① Hold down [⏻] to turn ON the power.
- ② Set the volume and squelch levels.
You can enter each adjust mode with [VOL/SQL MONI].
 - ➔ Enter the squelch adjustment mode, and push [▼] several times to open the squelch.
 - ➔ Enter the volume adjustment mode, then push [▲]/[▼] to adjust the volume level.
 - ➔ Enter the squelch adjustment mode again, and push [▲] until the noise disappears.
- ③ Push [▲]/[▼] to select the channel.
 - When receiving a signal, “**BUSY**” appears and audio is emitted from the speaker.
 - Further adjustment of the audio may be necessary at this point.
- ④ Push [Hi/Lo \leftrightarrow O] to select the output power if necessary.
 - “**LOW**” appears when low power is selected, no indication when high power is selected.
 - Choose low power for short range communications, choose high power for longer distance communications.
 - Some channels are for low power only.
- ⑤ Hold down [PTT] to transmit, then speak into the microphone.
 - “**TX**” appears.
 - Channel 70 cannot be used for transmission.
- ⑥ Release [PTT] to receive.

IMPORTANT: To maximize the readability of your transmitted signal, pause a few seconds after pushing [PTT], hold the microphone 5 to 10 cm (2 to 4 inches) from your mouth and speak into the microphone at your normal voice level.

NOTE: The transceiver has a power save function to conserve the battery power. The power save function automatically activates when no signal is received for 5 seconds.

For U.S.A version: To prevent accidental prolonged transmission, the transceiver has a time-out timer function. This timer cuts off a transmission after 5 minutes of continuous transmission.

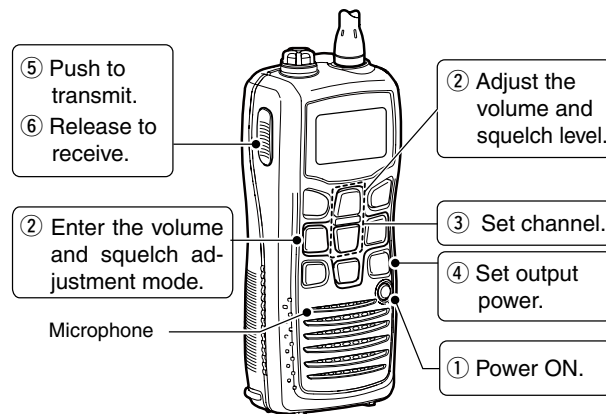

■ Call channel programming

The Call channel is used to access Channel 9 (default). However, you can enter the Call channel with your most often-used channels in each channel group for quick recall.

- ① Hold down [CH/WX U/I/C] for 1 second several times to select the channel group (USA, International or Canada) to be programmed. (p. 9)
- ② Hold down [16 9] for 1 second to select the Call channel of the selected channel group.
 - “CALL” and Call channel number appear.
- ③ Hold down [16 9] again for 3 seconds. (until a long beep changes to 2 short beeps) to enter the Call channel entering mode.
 - Channel number starts blinking.
- ④ Push [▲]/[▼] to select the channel.
- ⑤ Push [16 9] to program the displayed channel as the Call channel.
 - The channel number stops blinking.

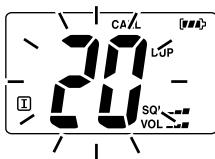
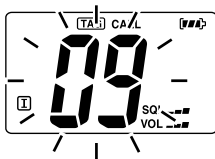

■ Adjusting the volume level

The volume level can be adjusted with [VOL/SQL MONI] and [▲]/[▼].

- ① Push [VOL/SQL MONI] once to enter the volume adjustment mode, then adjust the volume level with [▲]/[▼].
 - “VOL” indicator starts blinking.
 - The transceiver has 31 volume levels and OFF.
 - With no key operation is performed for 5 seconds, the transceiver returns to the normal condition.
- ② Push [VOL/SQL MONI] twice to exit the volume adjustment mode.

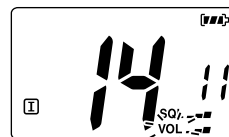

Indicates the volume level.

Blinks while adjusting the volume level.

4 BASIC OPERATION

■ Volume loud function

The volume loud function can be temporarily activated by pushing **[LOUD MUTE]**.

⚡ The function does not work when the volume level is 31.

- ① Push **[LOUD MUTE]** to activate the volume loud function.
 - The volume level is set to the maximum level (level 31).
 - The bars of the volume level indicator repeatedly appears in ascending order.
- ② Push **[LOUD MUTE]** again, or push **[VOL/SQL MONI]** to turn OFF the volume loud function.

■ Volume mute function

The volume mute function can be temporarily activated by holding down **[LOUD MUTE]**.

⚡ The function does not work when the volume level is OFF.

- ① Hold down **[LOUD MUTE]** for 1 second to activate the volume mute function.
 - The volume level is set to the minimum level (OFF).
 - The volume level indicator blinks.
- ② Push **[LOUD MUTE]** again, or push **[VOL/SQL MONI]** to turn OFF the volume mute function.

■ Adjusting the squelch level

The squelch level can be adjusted with **[VOL/SQL MONI]** and **[▲]/[▼]**.

To properly receive signals, as well as for the scan to function effectively, the squelch must be adjusted to the proper level.

- ① Push **[VOL/SQL MONI]** twice to enter the squelch adjustment mode, then adjust the squelch level with **[▲]/[▼]**.
 - “SQL” indicator starts blinking.
 - The transceiver has 11 squelch levels. OP is completely open, 10 is tight squelch, 1 is loose squelch.
 - With no key operation is performed for 5 seconds, the transceiver returns to the normal mode.
- ② Push **[VOL/SQL MONI]** again to exit the squelch adjustment mode.

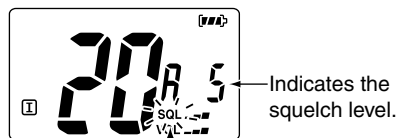

Blinks while adjusting the squelch level.

■ Lock function

This function electronically locks all keys (except for [PTT], [VOL/SQL MONI], [LOUD MUTE], [Hi/Lo ) and [▲]/[▼]*) to prevent accidental channel changes and function access.

* In the volume or squelch adjustment mode only.

- ➔ Hold down [Hi/Lo ) for 1 second to turn the lock function ON or OFF.

Appears while the lock function is activated.

Hold down
for 1 second

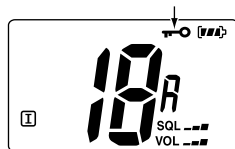

■ Monitor function

The monitor function opens the squelch. The monitor key action can be selected in the set mode. (p. 19)

- ➔ The monitor function is activated by holding down [VOL/SQL MONI] for 1 second.
 - “**BUSY**” blinks and the squelch is opened.

Blinks while the monitor function is activated.

Hod down
for 1 second

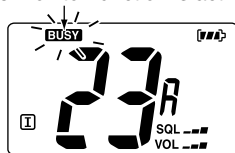

■ Automatic backlighting

This function lights the function display and keys, and it is convenient for night-time operation. The automatic backlighting can be activated in the set mode. (p. 19)

- ➔ Push any key except for [PTT] to turn ON the backlight.
 - The backlight is automatically turned OFF after 5 seconds of inactivity.

■ AquaQuake water draining function

The AquaQuake water draining function clears water away from the speaker grill. Without this function, water may muffle the sound coming from the speaker. The transceiver emits a vibrating sound when this function is activated.

- ➔ Hold down both [SCAN DUAL] and [Hi/Lo )].
 - A low tone sounds for 9 seconds to drain water, regardless of the volume level setting.
 - You cannot do any key operation while the AquaQuake function is activated.
 - The AquaQuake function can not be activated when an optional speaker-microphone is connected.

■ Scan types

Scanning is an efficient way to locate signals quickly over a wide frequency range. The transceiver has priority scan and normal scan.

In addition, the weather alert and auto scan functions are available for standby convenience. These functions can be simultaneously activated, depending on the setting in the set mode. (pp. 18, 19)

PRIORITY SCAN

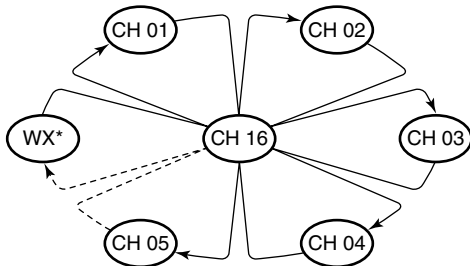

* Previously selected weather channel.
(when the weather alert function is activated)

Priority scan searches through all TAG channels in sequence while monitoring Channel 16. When a signal is detected on Channel 16, scan pauses until the signal disappears. When a signal is detected on a channel other than Channel 16, scan becomes Dualwatch until the signal disappears.

Set the TAG channels (scanned channels) before scanning. Clear the TAG for unwanted channels which inconveniently stop scanning, such as those for digital communications. (p. 15)

/// Choose the scan type from "Priority" or "Normal" in the set mode. (p. 18)

NORMAL SCAN

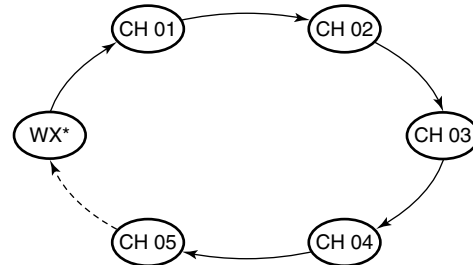

* Previously selected weather channel.
(when the weather alert function is activated)

Normal scan, like priority scan, searches through all TAG channels in sequence. However, unlike priority scan, Channel 16 is not checked unless Channel 16 is set as a TAG channel.

■ Setting TAG channels

For more efficient scanning, add channels as TAG channels or clear the TAG for unwanted channels.

Channels that are not tagged will be skipped during scanning. TAG channels can be independently assigned to each channel group (USA, International and Canada).

- ① Hold down **[CH/WX U//C]** for 1 second several times to select the channel group.
- ② Select the channel to be set as a TAG channel.
- ③ Hold down **[FAV TAG]** for 1 second to set the displayed channel as a TAG channel.
 - “TAG” appears on the display.
- ④ To cancel TAG channel setting, hold down **[FAV TAG]** for 1 second.
 - “TAG” disappears.

✓ Clearing (or setting) all tagged channels

While holding down **[FAV TAG]**, turn ON the power to clear all TAG channels in the selected channel group.

- Repeat above procedure to set all channels as TAG channels (when no TAG channel has been set.)

■ Starting a scan

First, set the weather alert function, priority scan function, scan resume timer and auto scan function, using the set mode. (pp. 18, 19)

- ① Hold down **[CH/WX U//C]** for 1 second several times to select the channel group.
 - When the weather alert function is in use, select the weather channel with **[CH/WX U//C]** and **[▲]/[▼]**.
- ② Push **[SCAN DUAL]** to start priority or normal scan.
 - “SCAN” blinks in the display.
 - “16” appears on the sub channel readout during priority scan.
 - When a signal is received, scan pauses until the signal disappears or resumes after pausing 5 seconds. according to the set mode setting.
 - Push **[▲]/[▼]** to check which channels have been set as TAG channels, change the scanning direction or resume the scan manually.
- ③ To stop the scan, push **[SCAN DUAL]**.
 - “SCAN” disappears.
 - Pushing **[PTT]**, **[16 9]**, **[CH/WX U//C]** or **[FAV TAG]** also stops the scan.

[Example]: Starting a normal scan.

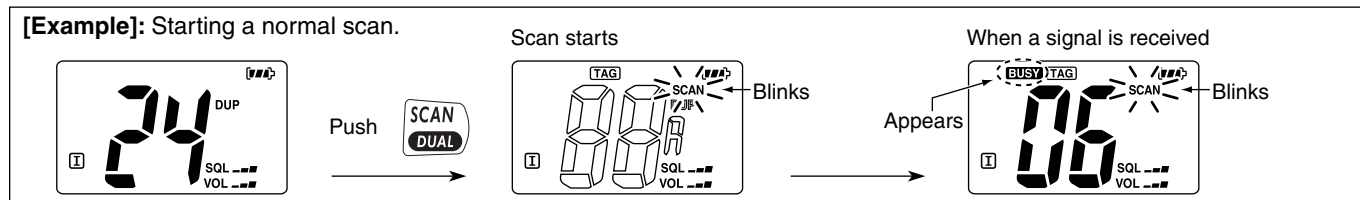

■ Description

Dualwatch monitors Channel 16 while you are receiving on another channel, Tri-watch monitors Channel 16 and the Call channel while receiving another channel. Dualwatch/Tri-watch is convenient for monitoring Channel 16 when you are operating on another channel.

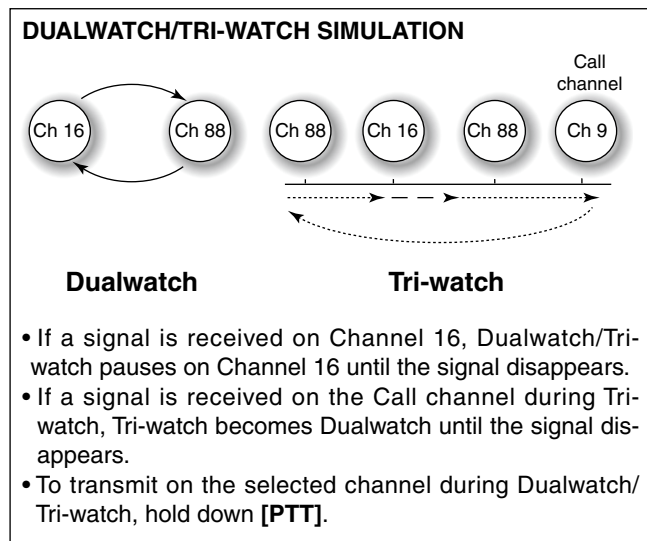

■ Operation

- ① Select Dualwatch or Tri-watch in the set mode. (p. 19)
- ② Select the channel.
- ③ Hold down **[SCAN DUAL]** for 1 second to start Dualwatch or Tri-watch (depending on the set mode setting).
 - “**DUAL**” blinks during Dualwatch, “**TRI**” blinks during Tri-watch.
 - A beep tone sounds when a signal is received on Channel 16.
 - Tri-watch becomes Dualwatch when receiving a signal on the Call channel.
- ④ To cancel Dualwatch/Tri-watch, push **[SCAN DUAL]** again.

[Example]: Operating Tri-watch on INT channel 07.

Tri-watch starts.

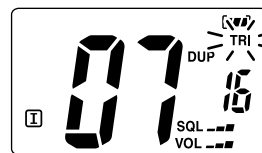

Signal is received on the Call channel.



Tri-watch resumes after the signal disappears.

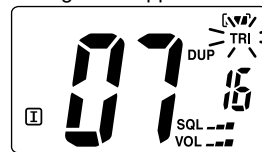

Signal received on Channel 16 takes priority.

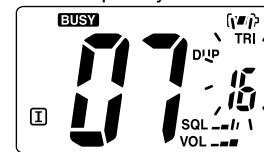

■ Set mode programming

Set mode is used to change the status or value of the transceiver's functions: Beep tone function, Weather alert function, Priority scan function, Scan resume timer, Auto scan function, Monitor key action, Automatic backlighting, LCD contrast setting, Power save function, Squelch sensitivity, Low fix function* and Noise detection function.

*Appears only when the optional battery case is attached.

◇ Set mode operation

- ① Turn OFF the power.
- ② While pushing **[VOL/SQL MONI]**, turn ON the power to enter the set mode.
 - "bP" appears.
- ③ Push **[VOL/SQL MONI]**, or push **[▲]/[▼]** while holding down **[VOL/SQL MONI]** to select the item.
- ④ Push **[▲]/[▼]** to select the value or option.
- ⑤ To exit the set mode, push **[16 9]**.

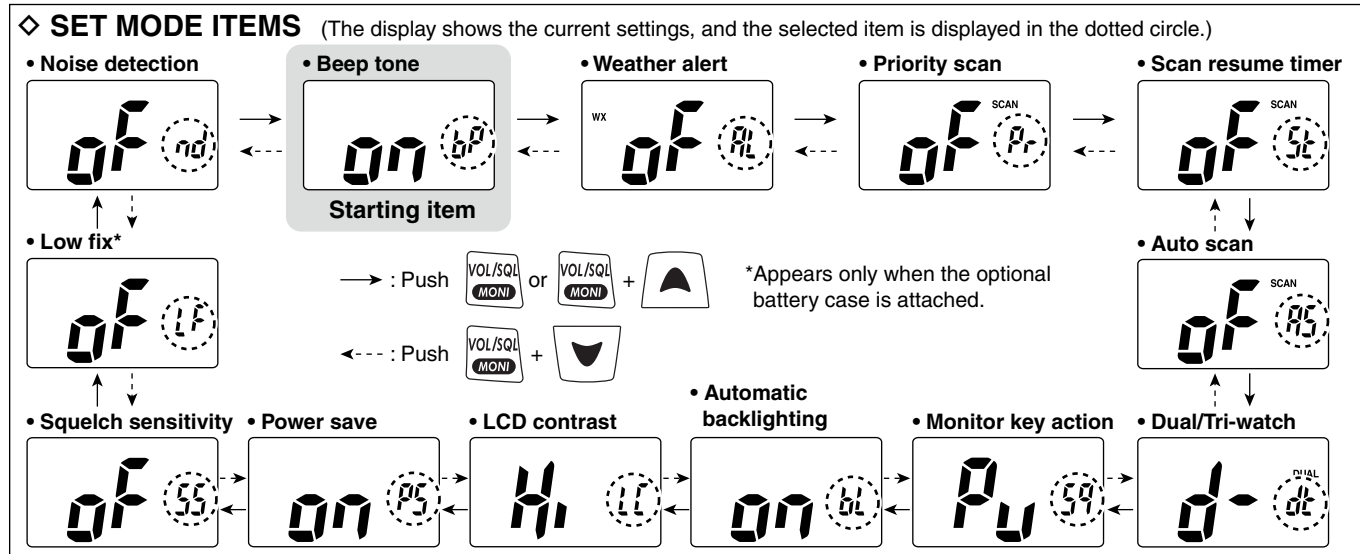

■ Set mode items

◇ Beep tone function

“bP”

Select the key touch beep sound from ON or US, or turn OFF the sound.

- OFF: For silent operation.
- ON : A fixed beep sounds.
- US : The preset beeps (example: do, re, mi) sound.



Beep tone ON (default)



Beep tone OFF

◇ Weather alert function

“AL”

A NOAA broadcast station transmits a weather alert tone before any important weather announcements. When the function is turned ON and the transceiver detect a weather alert tone, “WX ALT” indicator blinks and the transceiver emits a beep. The blinking stops when the transceiver is operated. The currently selected weather channel is checked while the power save function is activated or during scan.

• “ALT” appears when the function is set ON.



Weather alert function OFF (default)



Weather alert function ON

◇ Priority scan function

“Pr”

The transceiver has 2 scan types— normal (OFF) and priority (ON) scans. Normal scan searches all TAG channels in the selected channel group. Priority scan searches all TAG channels in sequence while monitoring Channel 16.

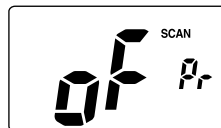

Normal scan (default)

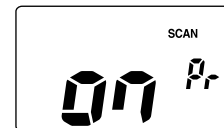

Priority scan

◇ Scan resume timer

“St”

The scan resume timer can be set as a pause (OFF) or timer scan (ON).

- OFF: When a signal is detected on a channel, scan pauses on the channel until the signal disappears, and then resumes.
- ON : When a signal is detected on a channel, scan pauses on the channel for 5 seconds, and then resumes.

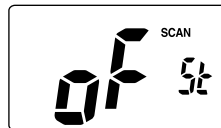

Scan resume timer OFF (default)

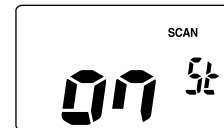

Scan resume timer ON

◇ **Auto scan function** “AS”

The auto scan function starts normal or priority scan automatically when no signal is received, and no operation is performed for 30 seconds.

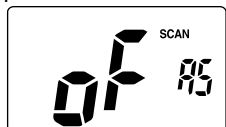

Auto scan OFF (default)



Auto scan ON

◇ **Dual/Tri-watch function** “dt”

This item can be set as Dualwatch or Tri-watch. (p. 16)

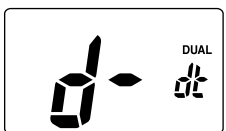

Dualwatch function (default)

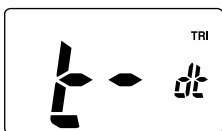
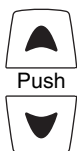

Tri-watch function

◇ **Monitor key action** “Sq”

The monitor key opens the squelch temporarily. This item sets the key action.

- Pu (PUSH) : The monitor function is activated by holding down [VOL/SQL MONI] for 1 second. The squelch opens while holding down the key.
- Ho (HOLD) : The monitor function is activated by holding down [VOL/SQL MONI] for 1 second. The squelch stays open until any key is pushed.

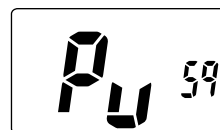

Push setting (default)

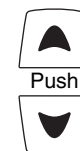

Hold setting

◇ **Automatic backlighting** “bL”

This function is convenient for night-time operation. The backlight can be selected from ON and OFF.

- The backlight is automatically activated when any key except for [PTT] is pushed.
- The backlight is automatically turned OFF after 5 seconds of inactivity.



Auto backlighting ON (default)

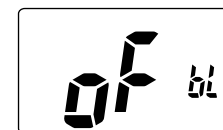
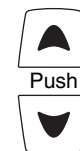

Auto backlighting OFF

◇ **LCD contrast setting** “LC”

Set the LCD contrast level from High contrast and Low contrast.

☞ The LCD contrast level makes no difference for indoor use.



High contrast (default)

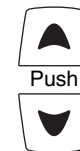

Low contrast

7 SET MODE

◇ Power save function “PS”

The power save function reduces current drain by deactivating the receiver circuit for preset intervals.

- OFF : The power save function is turned OFF.
- ON : The power save function is turned ON. The power save function will be activated when no signal is received, and no operation is performed for 5 seconds.

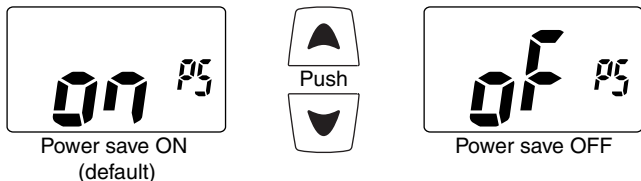

◇ Squelch sensitivity “SS”

When this function is turned ON, rejection of noise is improved so that the audio is not easily affected by noise.

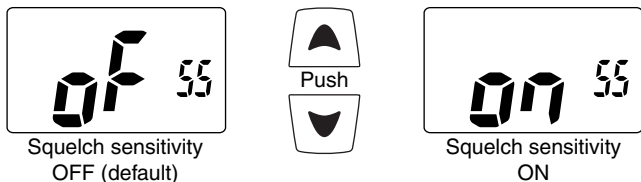

◇ Low fix function “LF”

(Appears only when the optional battery case is attached.)
When this function is turned ON, the output power is fixed to low except for Channel 16.

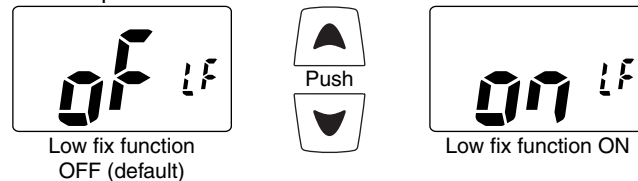

◇ Noise detection function “nd”

The noise detection function enables the transceiver to detect the ambient noise while in the standby condition. If the detecting noise and the received signal are stronger than the specific level, the transceiver increases the volume level automatically to suit the environment when receiving a signal.

/// When the squelch is open, the transceiver will not detect noise.

- OFF: The noise detection function is turned OFF.
- Low : When the detecting noise is louder than the specific level, the transceiver turns up the volume.
- High : When the detecting noise is louder than the specific level, the transceiver turns up the volume greater than "Low" setting.

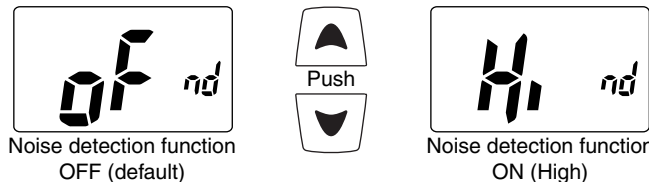

◇ Battery caution

Misuse of Lithium-ion batteries may result in the following hazards: smoke, fire, or the battery may rupture. Misuse can also cause damage to the battery or degradation of battery's performance.

⚠ **DANGER! NEVER** solder the battery terminals, or **NEVER** modify the battery pack. This may generate heat in the battery, and the battery pack may burst, emit smoke or catch fire.

⚠ **DANGER! NEVER** leave battery pack in areas with temperatures above 60°C (140°F). High temperature buildup in the battery, such as could occur near fires or stoves, inside a sun-heated car, or by setting the battery in direct sunlight for long periods of time may cause the battery to rupture or catch fire. Excessive temperatures may also degrade battery performance or shorten battery life.

⚠ **DANGER! NEVER** strike or otherwise impact the battery. Do not use the battery if it has been severely impacted or dropped, or if the battery has been subjected to heavy pressure. Battery damage may not be visible on the outside of the case. Even if the surface of the battery does not show cracks or any other damage, the cells inside the battery may rupture or catch fire.

⚠ **DANGER! KEEP** battery packs away from fire. Fire or heat may cause them to rupture or explode. Dispose of an used battery pack in accordance with local regulations.

⚠ **DANGER! NEVER** expose the battery to rain, snow, saltwater, or any other liquids. Never charge or use a wet battery. If the battery gets wet, be sure to wipe it dry before using. The battery by itself is not waterproof.

⚠ **DANGER! NEVER** use the battery with a transceiver for which it is not specified. Never use a battery with any other equipment, or for any purpose that is not specified in this instruction manual.

⚠ **DANGER! NEVER** let fluid from inside the battery get in your eyes. If it does, blindness can result. Rinse your eyes with clean water, without rubbing them, and immediately go to a doctor.

⚠ **WARNING! NEVER** put the battery in a microwave oven, high-pressure container, or in an induction heating cooker. This could cause a fire, overheating, or cause the battery to rupture.

⚠ **WARNING! NEVER** use the battery if it emits an abnormal odor, heats up, or is discolored or deformed. If any of these conditions occur, contact your Icom dealer or distributor.

⚠ **WARNING! NEVER** use deteriorated battery packs. They could cause a fire.

⚠ **WARNING!** let fluid from inside the battery come in contact with your body. If it does, immediately wash with clean water.

8 BATTERY CHARGING

CAUTION: DO NOT use the battery out of the specified temperature range for the transceiver ($-20^{\circ}\text{C} \sim +60^{\circ}\text{C}$, $-4^{\circ}\text{F} \sim +140^{\circ}\text{F}$). and the battery itself ($-20^{\circ}\text{C} \sim +60^{\circ}\text{C}$, $-4^{\circ}\text{F} \sim +140^{\circ}\text{F}$). Using the battery out of its specified temperature range will reduce the battery's performance and battery life. Please note that the specified temperature range of the battery may exceed that of the transceiver. In such cases, the transceiver may not work properly because it is out of its operating temperature range.

CAUTION: Shorter battery life could occur if the battery is left fully charged, completely discharged, or in an excessive temperature environment (above 60°C , 140°F) for an extended period of time. If the battery must be left unused for a long time, it must be detached from the radio after discharging. You may use the battery until the remaining capacity is about half, then keep it safely in a cool dry place with the temperature range as below:

- $-20^{\circ}\text{C} \sim +50^{\circ}\text{C}$ ($-4^{\circ}\text{F} \sim +122^{\circ}\text{F}$) (within a month)
- $-20^{\circ}\text{C} \sim +35^{\circ}\text{C}$ ($-4^{\circ}\text{F} \sim +95^{\circ}\text{F}$) (within three months)
- $-20^{\circ}\text{C} \sim +20^{\circ}\text{C}$ ($-4^{\circ}\text{F} \sim +68^{\circ}\text{F}$) (within a year)

BE SURE to replace the battery pack with a new one approximately five years after manufacturing, even if it still holds a charge. The inside battery material will become weak after a period of time, even with little use. The estimated number of times you can charge the battery is between 300 and 500.

Even when the battery appears to be fully charged, the operating time of the transceiver may become short when:

- Approximately five years have passed since the battery was manufactured.
- The battery has been repeatedly charged.

◇ Charging caution

⚠ **DANGER! NEVER** charge the battery pack in areas with extremely high temperatures, such as near fires or stoves, inside a sun-heated car, or in direct sunlight. In such environments, the safety/protection circuit in the battery will activate, causing the battery to stop charging.

⚠ **WARNING! NEVER** charge the transceiver during a lightning storm. It may result in an electric shock, cause a fire or damage the transceiver. Always disconnect the power adapter before a storm.

⚠ **WARNING! NEVER** charge or leave the battery in the battery charger beyond the specified time for charging. If the battery is not completely charged by the specific time, stop charging and remove the battery from the battery charger. Continuing to charge the battery beyond the specific time limit may cause a fire, overheating, or the battery may rupture.

⚠ **WARNING!** Occasionally observe the battery pack condition while charging. If any abnormal condition occurs, discontinue using the battery pack.

⚠ **WARNING! NEVER** insert the transceiver (battery attached to the transceiver) into the charger if it is wet or soiled. This could corrode the battery charger terminals or damage the charger. The charger is not waterproof.

CAUTION: DO NOT charge the battery outside of the specific temperature range: $0^{\circ}\text{C} \sim 40^{\circ}\text{C}$ ($32^{\circ}\text{F} \sim 104^{\circ}\text{F}$). Icom recommends charging the battery at 20°C (68°F). The battery may heat up or rupture if charged out of the specific temperature range. Additionally, battery performance or battery life may be reduced.

■ Supplied battery charger

(Optional for some transceiver versions)

◆ Charging connections

⚡ Do not charge batteries other than the BP-252.

- ① Attach the BC-173 to a flat surface, such as a desk, with the two supplied screws, if necessary.
- ② Connect the power adapter as shown below.
- ③ Insert the battery pack with/without the transceiver into the charger.
 - The charge indicator lights orange.
 - The charge indicator blinks orange (or orange/green alternately) when the protector is activated.
- ④ Charge the battery pack approximately 10 hours, depending on the remaining power condition.
 - The charge indicator lights green when charging is completed.

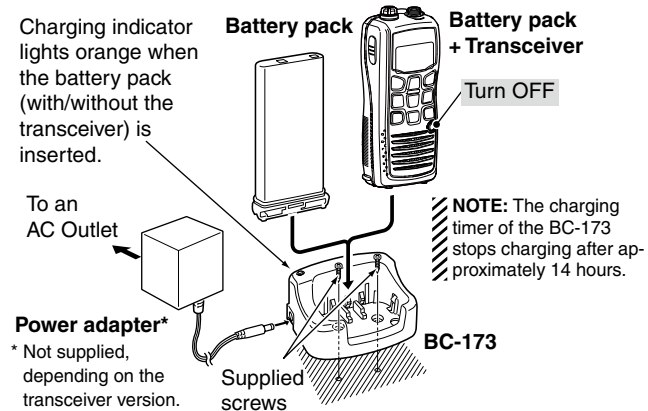

■ Optional battery case

When you would like to use the optional AAA(LR03) size battery case (BP-251), install the batteries as illustrated below. Be sure to observe the correct polarity.

⚡ CAUTION:

- When installing batteries, make sure they are all the same brand, type and capacity. Also, do not mix new and old batteries together.
- Keep battery contacts clean. It's a good idea to occasionally clean battery.
- When using the optional battery case, output power level is 2 W (at high).

⚡ NOTE: The transceiver may sink when the optional battery case is attached. (Depends on the weight of the installed batteries.)

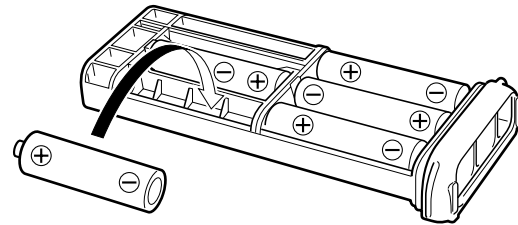

8 BATTERY CHARGING

■ Optional battery charger

◇ BC-162 installation

• To a desktop

Supplied screws

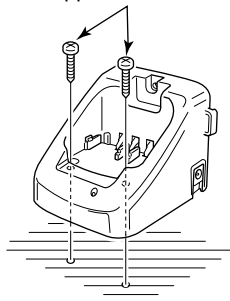

• To a wall

Supplied screws

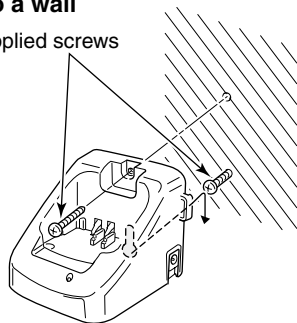

• For added stability

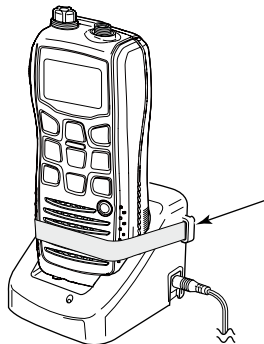

Eyelet:

Use a rubber band to secure the transceiver, if necessary.

◇ Charging

- ① Connect the power adapter as shown below.
- ② Insert the battery pack with/without the transceiver into the charger.
 - The charge indicator lights orange.
 - The charge indicator blinks orange (or red) when the protector is activated.
- ③ Charge the battery pack approx. 2 hours, depending on the remaining power level.
 - The charge indicator lights green when charging is completed.

NOTE: The battery charger, BC-162, has a charging timer. The timer stops the charging process after approximately 4 hours.

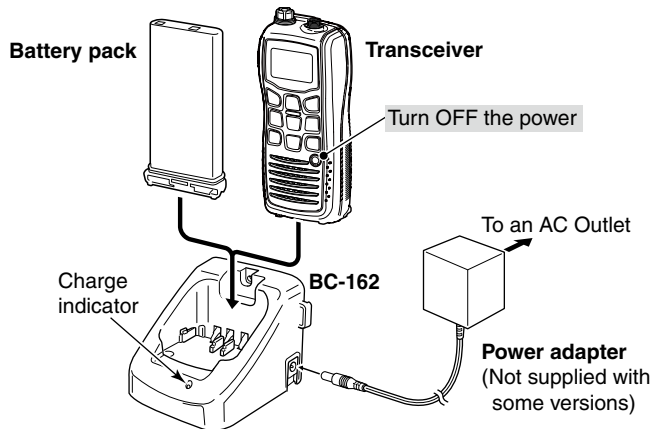

■ HM-165 descriptions

Alligator type clip

To attach the speaker-microphone to your shirt or collar, etc.

PTT switch

Transmits during push.
Receives during release.

Microphone

Speaker

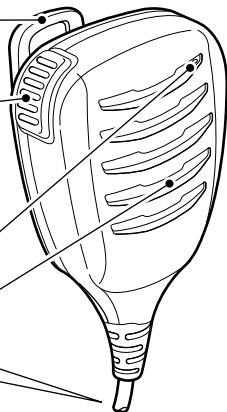

Turn OFF the transceiver power when connecting the HM-165.

NEVER immerse the connector in water. If the connector gets wet, be sure to dry it **BEFORE** attaching it to the transceiver.

NOTE: The microphone is located at the top of the speaker-microphone, as shown above. To maximize the readability of your transmitted signal (voice), hold the microphone approximately 5 to 10 cm (2 to 4 inches) from your mouth, and speak at your normal voice level.

NOTE: When the speaker-microphone is connected to the transceiver, the noise cancellation is disabled.

■ Attachment

Turn OFF the power before attaching the speaker-microphone. Then, insert the speaker-microphone connector into the **[SP MIC]** connector and carefully screw it tight, as shown below. Be careful not to cross-thread the connection.

IMPORTANT: KEEP the transceiver's **[SP MIC]** cap attached when the speaker-microphone is not in use. If the cover is not attached, water will get into the transceiver. Moreover, the terminals (pins) will become rusty, or the transceiver will function abnormally if the connector gets wet.

CAUTION: Securely attach the speaker-microphone's connector to prevent accidental loss, or water intrusion in the connector.

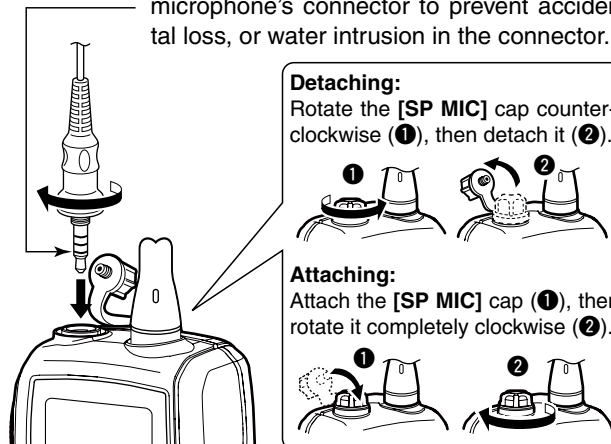

Detaching:

Rotate the **[SP MIC]** cap counter-clockwise (1), then detach it (2).





Attaching:

Attach the **[SP MIC]** cap (1), then rotate it completely clockwise (2).



10 TROUBLESHOOTING

PROBLEM	POSSIBLE CAUSE	SOLUTION	REF.
The transceiver does not turn ON.	<ul style="list-style-type: none"> • The battery is exhausted. • The battery pack is not correctly attached. 	<ul style="list-style-type: none"> • Recharge the battery pack. • Correctly attach the battery pack. 	p. 23 p. 3
No sound comes from the speaker.	<ul style="list-style-type: none"> • The squelch level is too high. • Volume level is too low. • Speaker has been exposed to water. 	<ul style="list-style-type: none"> • Set the squelch level to the threshold level. • Adjust the audio level to a suitable level. • Drain water from the speaker. 	p. 12 p. 11 p. 13
Transmitting is impossible, or high power can not be selected.	<ul style="list-style-type: none"> • Some channels are for low power or receive only. • The battery is exhausted. • The battery is over charged. • The output power is set to low. 	<ul style="list-style-type: none"> • Change channels. • Recharge the battery pack. • Make sure the battery voltage is correct. • Push [Hi/Lo ] to select high power. 	pp. 8, 9, 27 p. 23 — p. 10
The displayed channel cannot be changed.	<ul style="list-style-type: none"> • Lock function is activated. 	<ul style="list-style-type: none"> • Hold down [Hi/Lo ] for 1 second to cancel the function. 	p. 13
Scan does not start.	<ul style="list-style-type: none"> • “TAG” channels are not programmed. 	<ul style="list-style-type: none"> • Set the channels as “TAG” channels. 	p. 15
No beep sounds.	<ul style="list-style-type: none"> • Beep tone function is turned OFF. 	<ul style="list-style-type: none"> • Set the beep tone function to ON (Fix Beep/User Beep) in the set mode. 	p. 18
Battery voltage error.	<ul style="list-style-type: none"> • The connected battery pack’s voltage is more than 11 V. 	<ul style="list-style-type: none"> • Make sure the battery voltage is correct. 	—
The noise cancellation does not work.	<ul style="list-style-type: none"> • The sub-microphone is covered with something. • An optional external speaker-microphone is connected. 	<ul style="list-style-type: none"> • Make sure the sub-microphone is not covered. • Disconnect the microphone. 	p. 4 p. 25
The noise detection function does not work.	<ul style="list-style-type: none"> • The sub-microphone is covered with something. • The squelch is open. 	<ul style="list-style-type: none"> • Make sure the sub-microphone is not covered. • Set the squelch level. 	p. 4 p. 12

VHF MARINE CHANNEL LIST 11

Channel number			Frequency (MHz)	
USA	INT	CAN	Transmit	Receive
	01	01	156.050	160.650
01A	01A		156.050	156.050
	02	02	156.100	160.700
	03	03	156.150	160.750
	04		156.200	160.800
		04A	156.200	156.200
	05		156.250	160.850
05A	05A	05A	156.250	156.250
06	06	06	156.300	156.300
	07		156.350	160.950
07A	07A	07A	156.350	156.350
08	08	08	156.400	156.400
09	09	09	156.450	156.450
10	10	10	156.500	156.500
11	11	11	156.550	156.550
12	12	12	156.600	156.600
13 ^{*1}	13	13 ^{*1}	156.650	156.650
14	14	14	156.700	156.700
15 ^{*2}	15 ^{*1}	15 ^{*1}	156.750	156.750
16	16	16	156.800	156.800
17 ^{*1}	17	17 ^{*1}	156.850	156.850
	18		156.900	161.500
18A	18A	18A	156.900	156.900
	19		156.950	161.550
19A		19A	156.950	156.950
20	20	20 ^{*1}	157.000	161.600
20A			157.000	157.000
	21		157.050	161.650

Channel number			Frequency (MHz)	
USA	INT	CAN	Transmit	Receive
21A	21A	21A	157.050	157.050
		21b	Rx only	161.650
	22		157.100	161.700
22A	22A	22A	157.100	157.100
	23	23	157.150	161.750
23A	23A		157.150	157.150
		23b	RX only	161.750
24		24	157.200	161.800
25		25	157.250	161.850
		25b	Rx only	161.850
26		26	157.300	161.900
27	27	27	157.350	161.950
	27A		157.350	157.350
28	28	28	157.400	162.000
	28A		157.400	157.400
		28b	Rx only	162.000
	60	60	156.025	160.625
	61		156.075	160.675
		61A	156.075	156.075
	62		156.125	160.725
		62A	156.125	156.125
	63		156.175	160.775
63A	63A	63A	156.175	156.175
	64	64	156.225	160.825
		64A	156.225	156.225
	65		156.275	160.875
65A	65A	65A ^{*1}	156.275	156.275
	66		156.325	160.925

Channel number			Frequency (MHz)	
USA	INT	CAN	Transmit	Receive
66A	66A	66A ^{*1}	156.325	156.325
67 ^{*1}	67	67	156.375	156.375
68	68	68	156.425	156.425
69	69	69	156.475	156.475
71	71	71	156.575	156.575
72	72	72	156.625	156.625
73	73	73	156.675	156.675
74	74	74	156.725	156.725
	75 ^{*1}	75 ^{*1}	156.775	156.775
	76 ^{*1}	76 ^{*1}	156.825	156.825
77 ^{*1}	77	77 ^{*1}	156.875	156.875
	78		156.925	161.525
78A		78A	156.925	156.925
	79		156.975	161.575
79A		79A	156.975	156.975
	80		157.025	161.625
80A	80A	80A	157.025	157.025
	81		157.075	161.675
81A	81A	81A	157.075	157.075
	82		157.125	161.725
82A	82A	82A	157.125	157.125
	83		157.175	161.775
83A	83A	83A	157.175	157.175
		83b	Rx only	161.775
84		84	157.225	161.825
85		85	157.275	161.875
86		86	157.325	161.925
87	87	87	157.375	157.375

Channel number			Frequency (MHz)	
USA	INT	CAN	Transmit	Receive
88	88	88	157.425	157.425
	19A		156.950	156.950
	20A		157.000	157.000
	78A		156.925	156.925
	79A		156.975	156.975
	19b		Rx only	161.550
	20b		Rx only	161.600
	78b		Rx only	161.525
	79b		Rx only	161.575

WX channel	Frequency (MHz)	
	Transmit	Receive
1	RX only	162.550
2	RX only	162.400
3	RX only	162.475
4	RX only	162.425
5	RX only	162.450
6	RX only	162.500
7	RX only	162.525
8	RX only	161.650
9	RX only	161.775
10	RX only	163.275

^{*1} Low power only. ^{*2} RX only.

NOTE: Simplex channels, 21A, 23A, 81A, 82A and 83A **CANNOT** be lawfully used by the general public in USA waters.

NOTE: The international channels from 19A to 79b after channel 88 represent the 4-digit channels listed below:
 19A = 1019, 20A = 1020, 78A = 1078, 79A = 1079,
 19b = 2019, 20b = 2020, 78b = 2078, 79b = 2079.

12 SPECIFICATIONS AND OPTIONS

■ Specifications

◇ GENERAL

- Frequency coverage: Transmit 156.025–157.425 MHz
Receive 156.050–163.275 MHz
- Mode: FM (16K0G3E)
- Channel spacing: 25 kHz
- Power supply requirement: BP-251 and BP-252 only
- Current drain (at 7.4 V DC): TX (6 W/1 W) 1.5 A/0.7 A typical
Max. audio 0.3 A typical (internal speaker)
0.2 A typical (external speaker)
Power save 10 mA typical
- Frequency stability: ±10 ppm
- Operating temperature range: –20°C to +60°C, –4°F to +140°F
- Dimensions: 62 (W) × 139.5 (H) × 43 (D) mm
(projections not included) 2⁷/₁₆ (W) × 5¹/₂ (H) × 1¹¹/₁₆ (D) inch
- Weight (approximately): 295 g, 10.4 oz
(incl. BP-252, FA-SC58V and MB-109)

◇ TRANSMITTER

- Output power (at 7.4 V DC): 6 W (High) and 1 W (Low)
- Modulation system: Variable reactance frequency modulation
- Maximum frequency deviation: ±5 kHz
- Adjacent channel power: 70 dB
- Spurious emissions: –68 dBc typical

◇ RECEIVER

- Receive system: Double-conversion superheterodyne
- Sensitivity (12 dB SINAD): 0.25 µV typical
- Squelch sensitivity: 0.35 µV typical (at threshold)
- Intermodulation: 70 dB typical
- Spurious response: 70 dB typical
- Adjacent channel selectivity: 70 dB typical
- Audio output power (at 10% distortion)
Internal speaker: 0.70 W typical into a 16 Ω load
External speaker: 0.35 W typical into an 8 Ω load

All stated specifications are subject to change without notice or obligation.

■ Options

◇ BATTERY CASE AND PACK

- **BP-251** BATTERY CASE
Battery case for 5 × AAA (LR03) alkaline cells.
Output power level: 2 W
- **BP-252** Li-ion BATTERY PACK
Voltage: 7.2 V
Capacity: 1000 mAh (minimum) / 1050 mAh (typical)

◇ CHARGERS

- **BC-173** DESKTOP CHARGER + **BC-147S** AC ADAPTER
Used for regular charging of battery pack. A power adapter is supplied with the charger depending on the version.
Charging time: Approximately 10 hours
- **BC-162** DESKTOP CHARGER + **BC-145S** AC ADAPTER
Used for rapid charging of battery pack. The power adapter, BC-145S, is not supplied with some versions.
Charging time: Approximately 2 hours.

◇ BELT CLIP

- **MB-109** BELT CLIP

◇ OTHER OPTIONS

- **HM-165** SPEAKER-MICROPHONE
Full sized speaker-microphone including an alligator clip to attach the microphone to your shirt, collar, etc. The HM-165 meets IPX7 requirements for waterproof protection. However, once it has been dropped, the IP rating cannot be guaranteed because of possible damage to its case or the waterproof seal.
- **FA-SC58V** ANTENNA

Some options may not be available in some countries. Please ask your dealer for details.



WARNING

Your Icom radio generates RF electromagnetic energy during transmit mode. This radio is designed for and classified as “General Population Use” in an uncontrolled environment. This radio has been evaluated for compliance at the distance of 2.5 cm (1 inch) with the FCC RF exposure limits for “General Population Use”. In addition, your Icom radio complies with the following Standards and Guidelines with regard to RF energy and electromagnetic energy levels and evaluation of such levels for exposure to humans:

- FCC OET Bulletin 65 Edition 01-01 Supplement C, Evaluating Compliance with FCC Guidelines for Human Exposure to Radio Frequency Electromagnetic Fields.
- American National Standards Institute (C95.1-2005), IEEE Standard for Safety Levels with Respect to Human Exposure to Radio Frequency Electromagnetic Fields, 3 kHz to 300 GHz.
- American National Standards Institute (C95.3-2002), IEEE Recommended Practice for the Measurement of Potentially Hazardous Electromagnetic Fields— RF and Microwave.
- The following accessories are authorized for use with this product. Use of accessories other than those specified may result in RF exposure levels exceeding the FCC requirements for wireless RF exposure.; Belt Clip (MB-109), Rechargeable Li-ion Battery Pack (BP-252) and Alkaline Battery Case (BP-251).



CAUTION

To ensure that your expose to RF electromagnetic energy is within the FCC allowable limits for general population use, always adhere to the following guidelines:

- **DO NOT** operate the radio without a proper antenna attached, as this may damaged the radio and may also cause you to exceed FCC RF exposure limits. A proper antenna is the antenna supplied with this radio by the manufacturer or antenna specifically authorized by the manufacturer for use with this radio.
- **DO NOT** transmit for more than 50% of total radio use time (“50% duty cycle”). Transmitting more than 50% of the time can cause FCC RF exposure compliance requirements to be exceeded. The radio is transmitting when the “transmit indicator” appears on the LCD. You can cause the radio to transmit by pressing the “PTT” switch.
- **ALWAYS keep** the antenna at least 2.5 cm (1 inch) away from the body when transmitting and only use the Icom belt-clips which are listed on p. 28 when attaching the radio to your belt, etc., to ensure FCC RF exposure compliance requirements are not exceeded. To provide the recipients of your transmission the best sound quality, hold the antenna at least 5 cm (2 inches) from your mouth, and slightly off to one side.

The information listed above provides the user with the information needed to make him or her aware of RF exposure, and what to do to assure that this radio operates with the FCC RF exposure limits of this radio.

Electromagnetic Interference/Compatibility

During transmissions, your Icom radio generates RF energy that can possibly cause interference with other devices or systems. To avoid such interference, turn off the radio in areas where signs are posted to do so. **DO NOT** operate the transmitter in areas that are sensitive to electromagnetic radiation such as hospitals, aircraft, and blasting sites.

Count on us!

A6710H-1EX-6
Printed in Japan
© 2008–2020 Icom Inc. Apr. 2020

Icom Inc.
1-1-32 Kamiminami, Hirano-ku, Osaka 547-0003, Japan